

OTC

Seeing Information Architectures

Presented by Dan Klyn

TUG



ontology taxonomy c

ontology taxonomy **choreography**

Report inappropriate predictions



ontology taxonomy choreography



Understanding Information Architecture ...
understandinggroup.com

CRITICAL COMPONENTS OF IA*

Ontology: Do you know what you mean when you say what you say?
Taxonomy: Have you provided logical structures that bring meaning to what you present?
Choreography: How is meaning affected across various channels, over time and through usage?

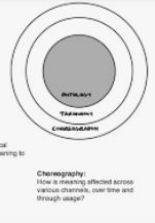

Ontology This is a fish.
slideshare.net

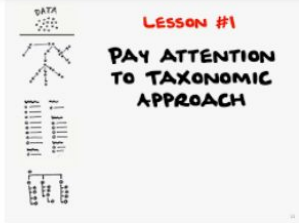

Lessons from an Ontology Nerd
slideshare.net



Information Architecture ...
kmrom.com

Ontology	Taxonomy	Choreography
Creating clear content that the user can understand.	Organizing content into categories that the user can easily identify and navigate.	Bringing Ontology and Taxonomy together to deliver a pleasing journey for the user.

design. - Wakefly Blog - Wakefly, Inc ...
wakefly.com

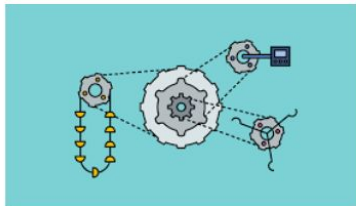

Understanding and refining choreography ...
blog.optimalworkshop.com

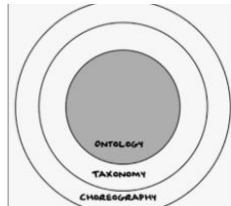

Talk About Ontology | UX Ma...
uxmag.com

ONTOLOGY Ontology = Meaning	TAXONOMY Taxonomy = Organization	CHOREOGRAPHY Choreography = Presentation
HERSTAND. designer, when considering the logic of content... is seeking to understand our users' interpreted information: page, words, signs/symbols.	ORGANIZE. We are consciously organizing content and naming it in ways that makes sense to our users.	APPLY. As a designer, when considering the Choreography of content... We are intentionally designing ways to deliver content to our user within a system...over time.

UX Design 101: Information Architecture ...
blog.prototypr.io

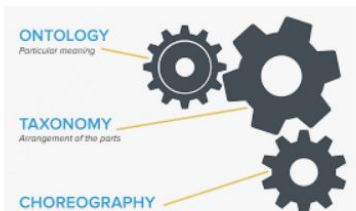

CRITICAL COMPONENTS OF IA*

Ontology: Do you know what you mean when you say what you say?
Taxonomy: Have you provided logical structures that bring meaning to what you present?
Choreography: How is meaning affected across various channels, over time and through usage?



explaining information architect: x +

https://vimeo...

vimeo



architecture

04:01

explaining information architecture

11 years ago | More

 Dan Klyn [+ Follow](#)

▶ 295K  203  19  7

[Share](#)





YALE
UNIVERSITY
ART
GALLERY

Ver
June 29-October 7, 20

Open to
the Public
Free
Admission

YALE UNIVERSITY ART GALLERY 1111 CHAPEL S

Free admission to
Yale University art
for the public Tuesday
through Sunday Free
memberships

BICYCLE ROUTE
WESTVILLE











JÖNKÖPING UNIVERSITY

@resmini



TUG The *Understanding* Group



@danklyn

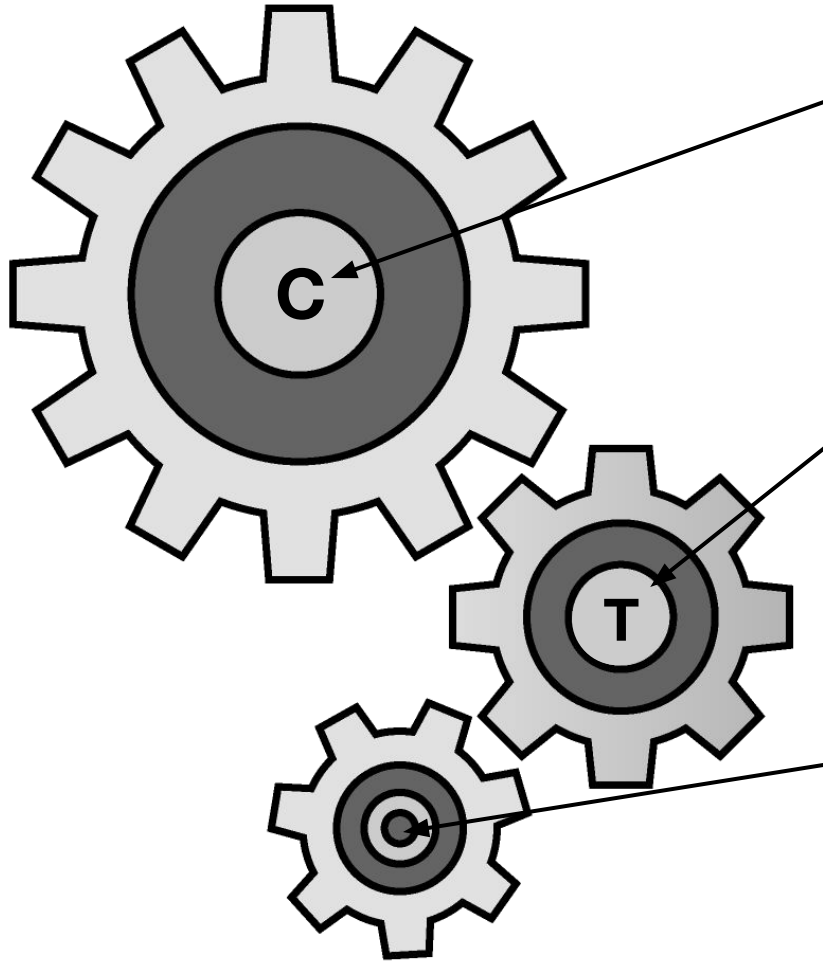

Choreography

Systemics: Rules and Morphologies

Topology

Situatedness: Spatial Relationships

Ontology

Suchness: Intrinsic Bases For Classification

PITCH

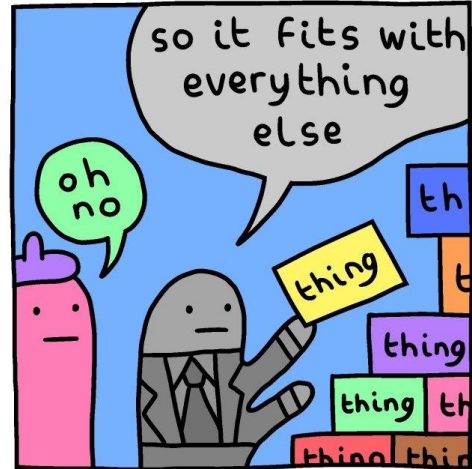
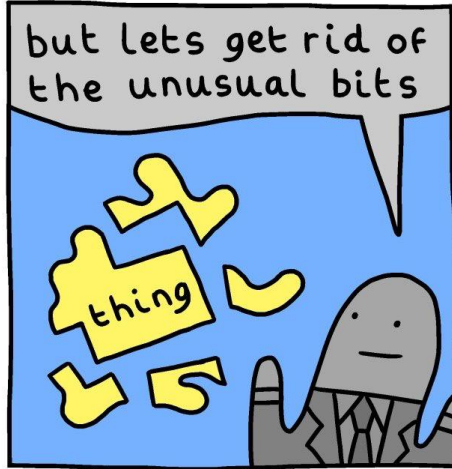
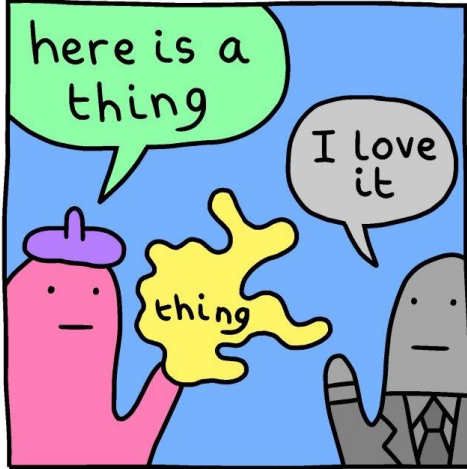

webcomicname.com



Groceries, Pharmacy, Electronics x +





https://www.meijer.com/index.html

mPerks delivery/pickup pharmacy photo credit card Weekly Ad Nearest Store: Alpine

meijer Shop Departments Search products

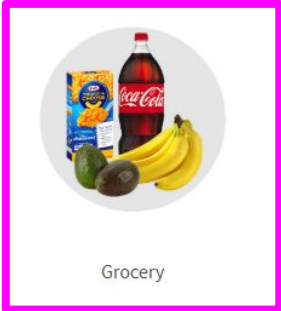
shop by department

Browse items across the store for home delivery or pickup.

-  Meijer Made
-  Grocery
-  Household Essentials
-  Beauty & Personal Care
-  School Essentials
-  view all

Shop All Departments

find all your favorites on sale

we're in this year together





Shop Departments ▾

Search products 🔍



shop by category



Snacks



Beverages



Dairy



Frozen



Cereal & Breakfast



Pantry



Browser tabs: m Groceries, Pharmacy, Electronics x +

Address bar: https://www.meijer.com/index.html







Browser tabs: mPerks | Grocery | Meijer x +



Address bar: https://www.meijer.com/departments/grocery.html?cid=Departments:Grocery

Navigation: mPerks delivery/pickup pharmacy photo credit card Weekly Ad Nearest Store: Alpine

meijer Shop Departments ▾ Search products 🔍

shop by category

- Snacks: 
- Beverages: 
- Dairy: 
- Frozen: 
- Cereal & Breakfast: 
- Pantry: 

- 
- 
- 

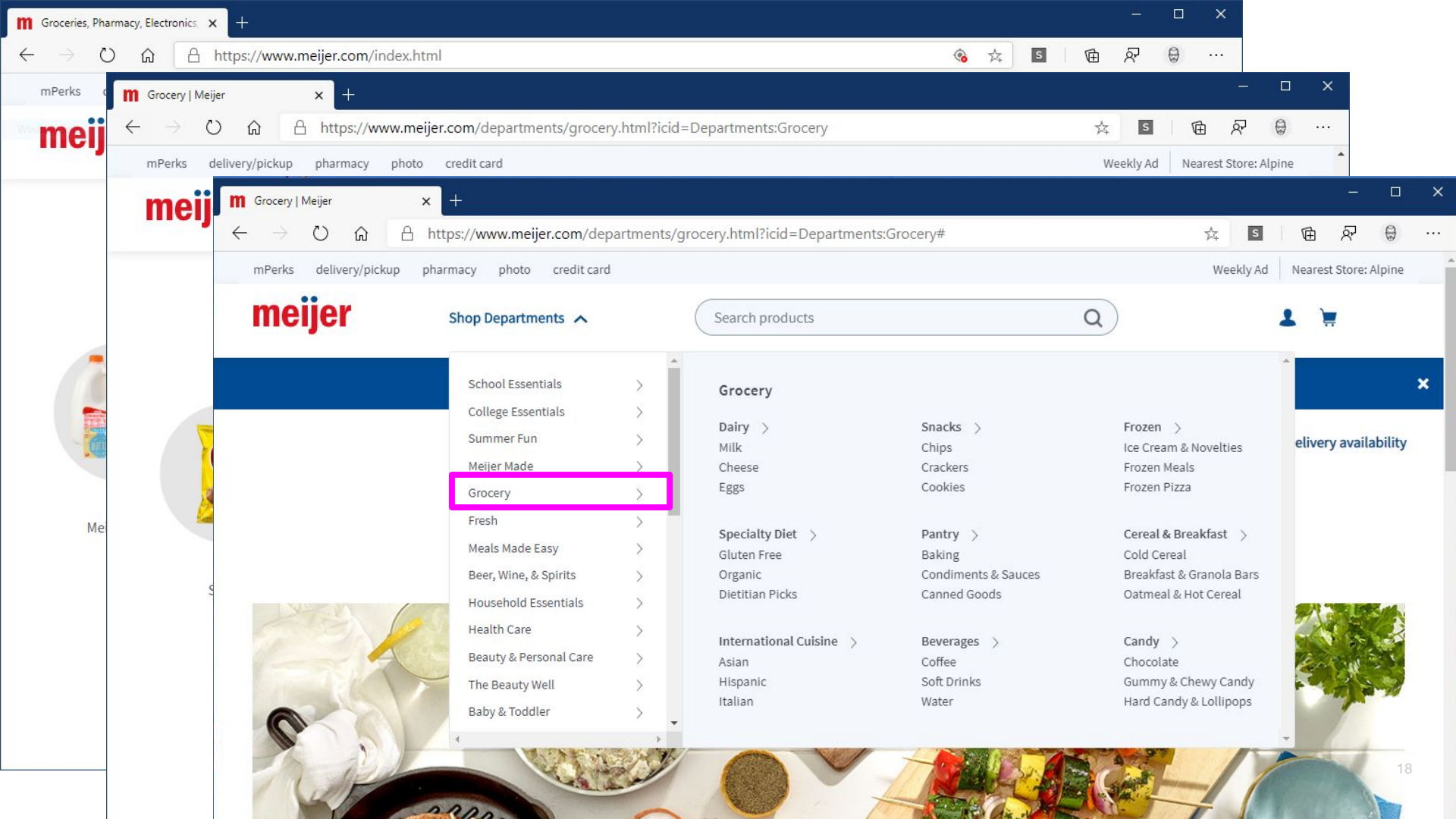

Shop Departments ^

Search products



- School Essentials >
- College Essentials >
- Summer Fun >
- Meijer Made >
- Grocery >**
- Fresh >
- Meals Made Easy >
- Beer, Wine, & Spirits >
- Household Essentials >
- Health Care >
- Beauty & Personal Care >
- The Beauty Well >
- Baby & Toddler >

Grocery

- Dairy >
- Milk
- Cheese
- Eggs

- Specialty Diet >
- Gluten Free
- Organic
- Dietitian Picks

- International Cuisine >
- Asian
- Hispanic
- Italian

- Snacks >
- Chips
- Crackers
- Cookies

- Pantry >
- Baking
- Condiments & Sauces
- Canned Goods

- Beverages >
- Coffee
- Soft Drinks
- Water

- Frozen >
- Ice Cream & Novelties
- Frozen Meals
- Frozen Pizza

- Cereal & Breakfast >
- Cold Cereal
- Breakfast & Granola Bars
- Oatmeal & Hot Cereal

- Candy >
- Chocolate
- Gummy & Chewy Candy
- Hard Candy & Lollipops

delivery availability

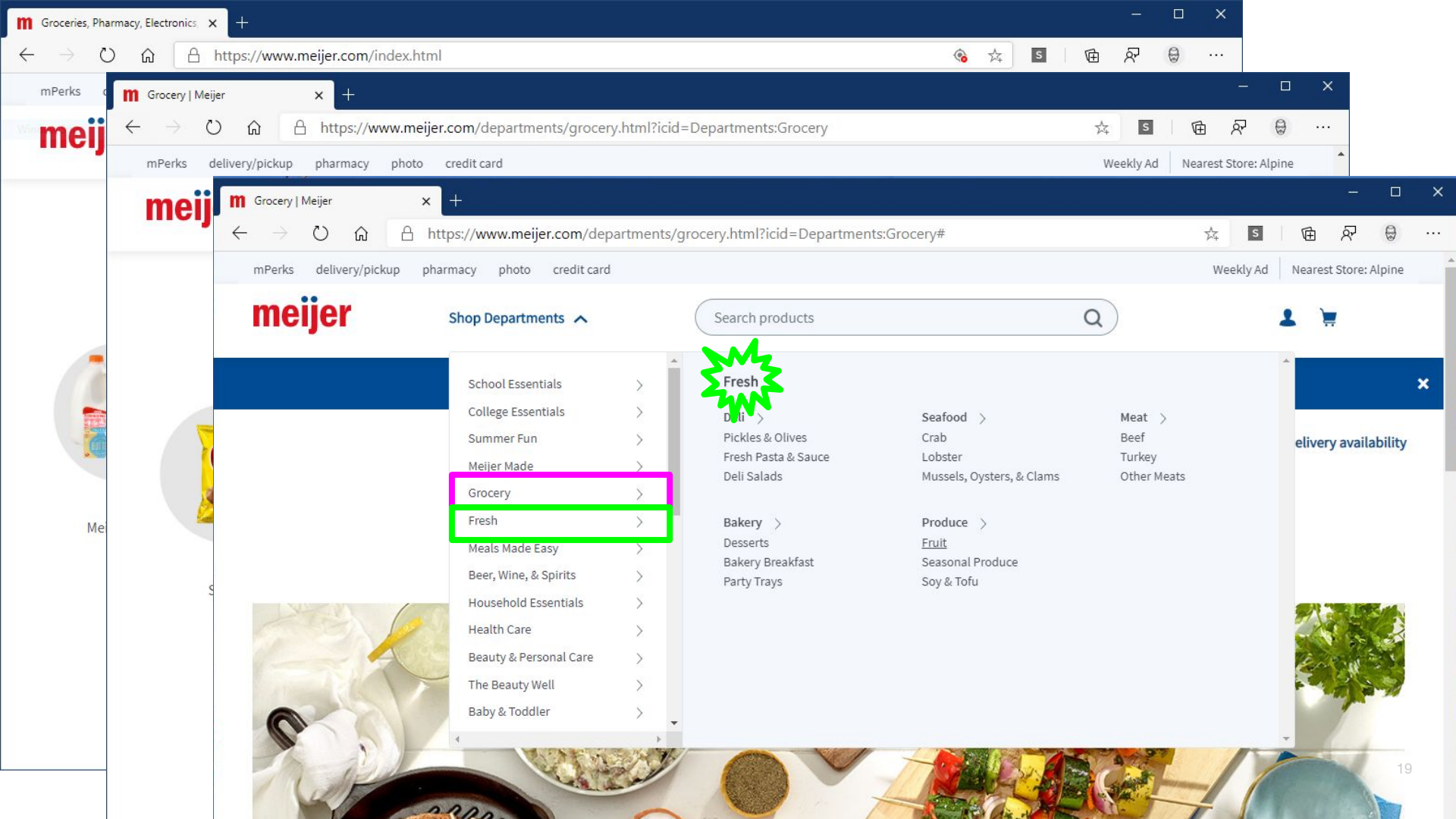

Shop Departments ^

Search products



- School Essentials >
- College Essentials >
- Summer Fun >
- Meijer Made >
- Grocery >
- Fresh >
- Meals Made Easy >
- Beer, Wine, & Spirits >
- Household Essentials >
- Health Care >
- Beauty & Personal Care >
- The Beauty Well >
- Baby & Toddler >

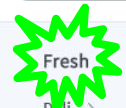

Fresh

Deli >

- Pickles & Olives
- Fresh Pasta & Sauce
- Deli Salads

Seafood >

- Crab
- Lobster
- Mussels, Oysters, & Clams

Meat >

- Beef
- Turkey
- Other Meats

Bakery >

- Desserts
- Bakery Breakfast
- Party Trays

Produce >

- Fruit
- Seasonal Produce
- Soy & Tofu

delivery availability



What is a department?

What is a category?

What is a berry?



A good question is worth more than
a brilliant answer.

—Louis I. Kahn

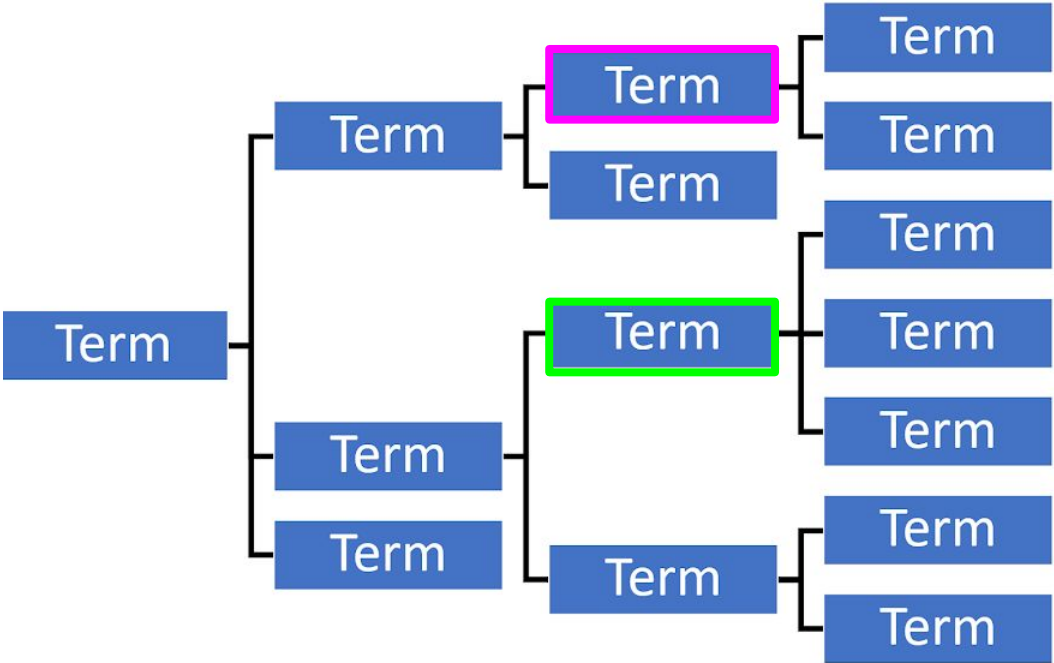



Berries



Joseph[®]
Joseph

1/4 tsp
1.25ml

1/2 tsp

1 tsp

1 tbs

1/4 cup

1/3 cup

1/2 cup

Vala Afshar on Twitter: "By x

Twitter, Inc. [US] <https://twitter.com/valaafshar/status/535432172534894592>

Home Notifications Messages # Discover Search Twitter

Vala Afshar @ValaAfshar **Following**

By 2020, 57,000 new "things" will be added to the Internet every 1 second.
huff.to/1rYqz4G

"How would you be interested in wearing/using a sensor device, assuming it was from a brand you trust, offering a service that interests you?"

The infographic features a central silhouette of a person with arms outstretched, wearing a black suit and white shirt. A dashed circular line surrounds the person, with various sensor locations marked by small icons and connected to data labels. The data labels are as follows:

Location	Percentage
Clipped onto clothing	29%
Wrist	28%
Upper arm	18%
Glasses	12%
Around chest	12%
Contact lenses	6%
Tattooed on skin	4%
Unlabeled	3%

What Before How



[understandinggroup.com](https://www.understandinggroup.com)



What Things Are

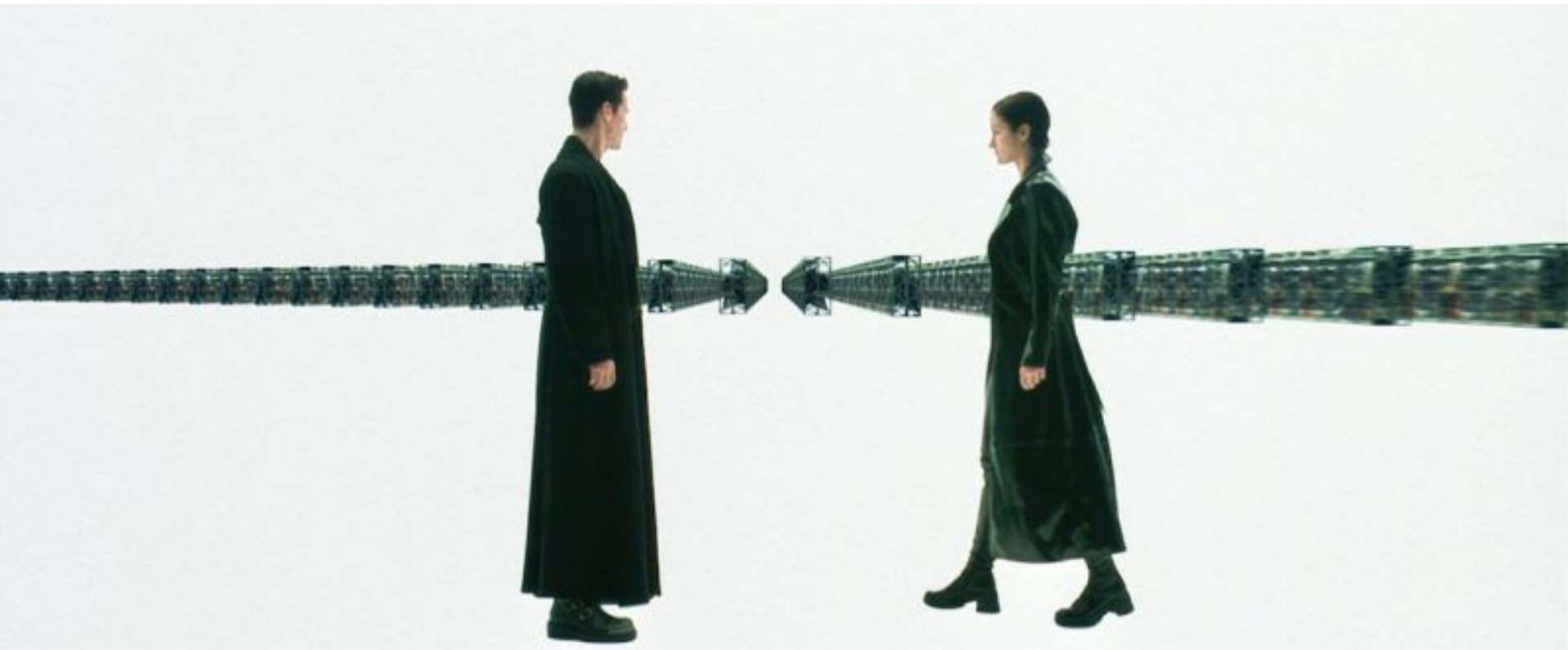

[understandinggroup.com](https://www.understandinggroup.com)





Berries



Berries



Anna Marquardt

@ajlobster



 Follow

She truly is the world's greatest athlete





Suchness?

That?

tathātā





Prices you can trust

LONG YELLOW THINGS

1/2 lb of Ecuador

.78 lb



understandinggroup.com





Situatedness?



understandinggroup.com

In as much as any entity within-the-world
is likewise in space,

its spatiality will have ontological
connection with the world.

Martin Heidegger, Being In Time (1927)

A man with curly grey hair and glasses, wearing a purple cardigan over a blue collared shirt, is seated in a gold, ornate chair. He is positioned in front of a large, colorful stained glass window with a diamond pattern. The word "Spatial" is overlaid in large white text across the center of the image.

Spatial



What Co-Ordinates?

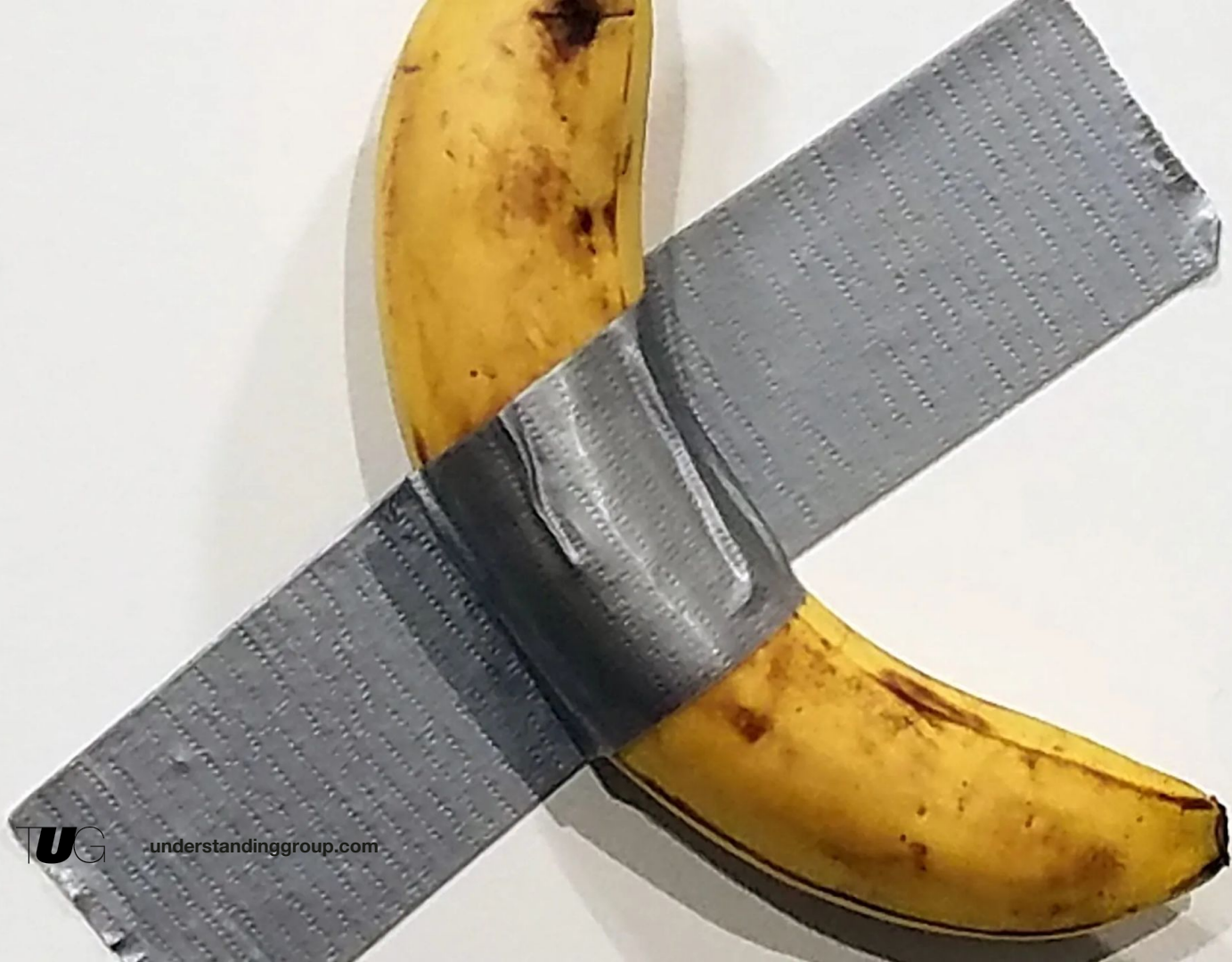



Systemics?



What Are The Steps?



understandinggroup.com



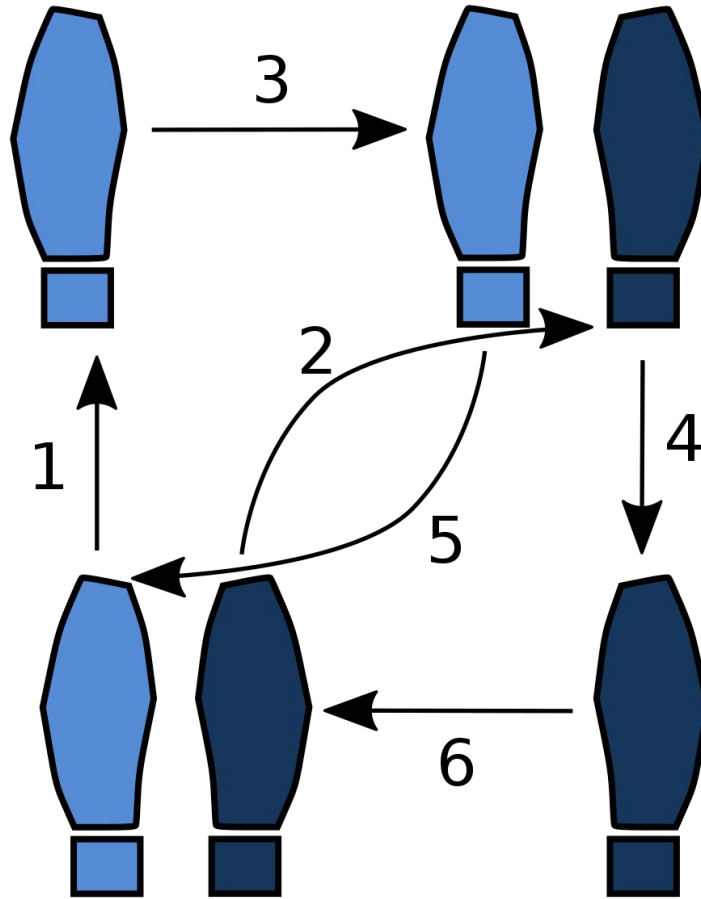



System Unavailable

The system is currently unavailable for one of the following reasons:

- You do not have access to the functionality you have requested.
- System is down for regularly scheduled maintenance. See [Administrative System Availability](#).
- The system is experiencing technical difficulties. Check [ITS Service Status](#) for up-to-date system status information.

For assistance, please contact the [ITS Service Center](#) or call 734-764-HELP (4357).

System Unavailable

The system is currently unavailable for one of the following reasons:

- You do not have access to the functionality you have requested.
- System is down for regularly scheduled maintenance. See [Administrative System Availability](#).
- The system is experiencing technical difficulties. Check [ITS Service Status](#) for up-to-date system status information.

Faculty Business

- Monday-Friday, 6 a.m.-4 a.m.
- Saturday, 6 a.m.-11 p.m.
- Sunday, 7:30 a.m.-Monday, 4 a.m.

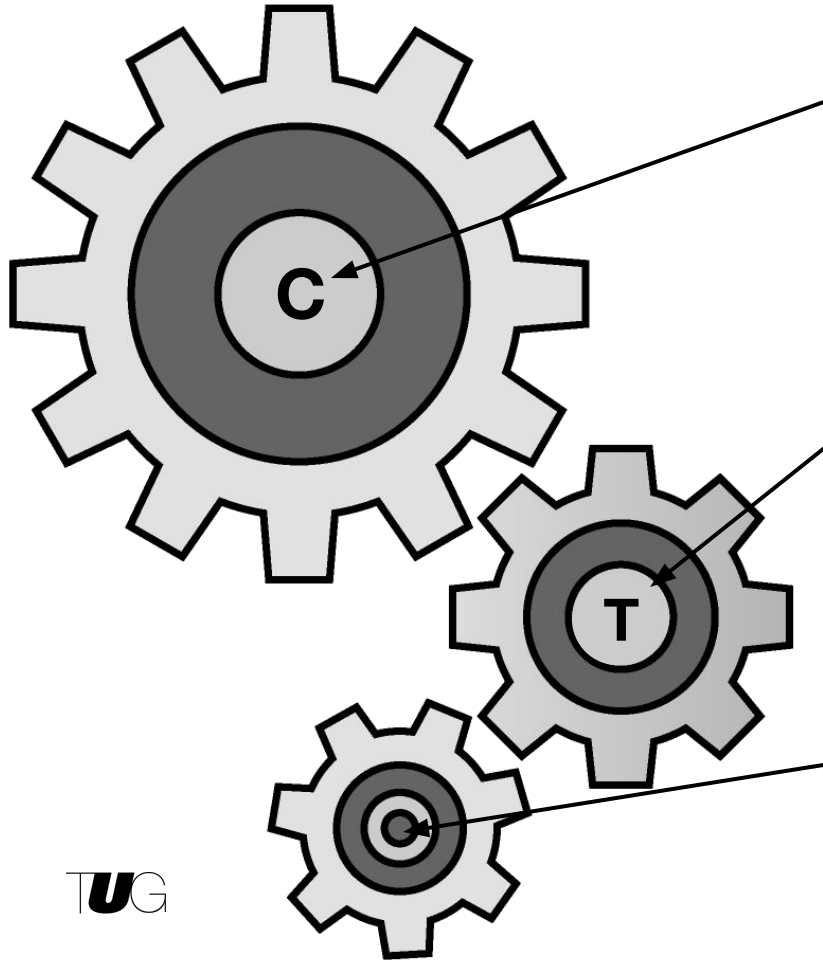

Choreography

Systemics: Rules and Morphologies

Topology

Situatedness: Spatial Relationships

Ontology

Suchness: Intrinsic Bases For Classification